

Descriptions

- Switching application
- Interface circuit and driver circuit application

Features

- With built-in bias resistors
- Simplify circuit design
- Reduce a quantity of parts and manufacturing process
- High packing density

PIN Connection

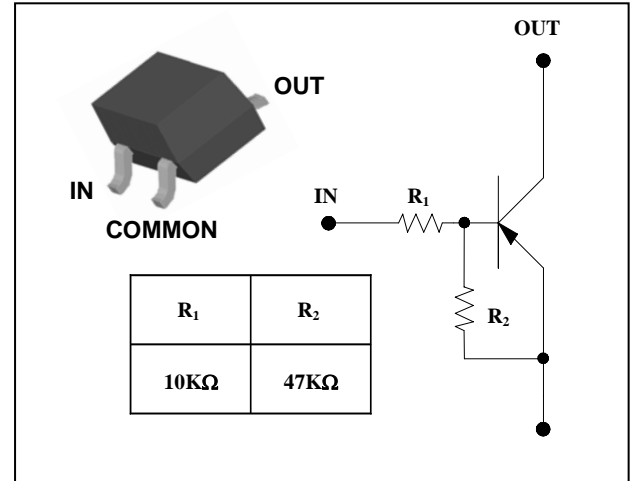

Ordering Information

| Type NO. | Marking | Package Code |
|----------|-----------------------------------|--------------|
| SRA2207S | $\overline{RA7}$ \square ① ② | SOT-23 |

① Device Code ② Year&Week Code

Absolute Maximum Ratings

(Ta=25°C)

| Characteristic | Symbol | Rating | Unit |
|---------------------------|-----------|-----------|------|
| Output voltage | V_O | -50 | V |
| Input voltage | V_I | -30, 6 | V |
| Output current | I_O | -100 | mA |
| Power dissipation | P_D | 200 | mW |
| Junction temperature | T_J | 150 | °C |
| Storage temperature range | T_{stg} | -55 ~ 150 | °C |

Electrical Characteristics

(Ta=25°C)

| Characteristic | Symbol | Test Condition | Min. | Typ. | Max. | Unit |
|---------------------------------|--------------|------------------------------------|------|------|-------|------------|
| Output cut-off current | $I_{O(OFF)}$ | $V_O = -50V, V_I = 0$ | - | - | -500 | nA |
| DC current gain | G_I | $V_O = -5V, I_O = -10mA$ | 80 | 150 | - | - |
| Output voltage | $V_{O(ON)}$ | $I_O = -10mA, I_I = -0.5mA$ | - | -0.1 | -0.3 | V |
| Input voltage (ON) | $V_{I(ON)}$ | $V_O = -0.2V, I_O = -5mA$ | - | - | -1.8 | V |
| Input voltage (OFF) | $V_{I(OFF)}$ | $V_O = -5V, I_O = -0.1mA$ | -0.5 | - | - | V |
| Transition frequency | f_T^* | $V_O = -10V, I_O = -5mA, f = 1MHz$ | - | 200 | - | MHz |
| Input current | I_I | $V_I = -5V, I_O = 0$ | - | - | -0.88 | mA |
| Input resistor (Input to base) | R_1 | - | 7 | 10 | 13 | K Ω |
| Input resistor (Base to common) | R_2 | - | 33 | 47 | 61 | K Ω |

* : Characteristic of transistor only

Electrical Characteristic Curves

Fig. 1 $P_c - T_a$

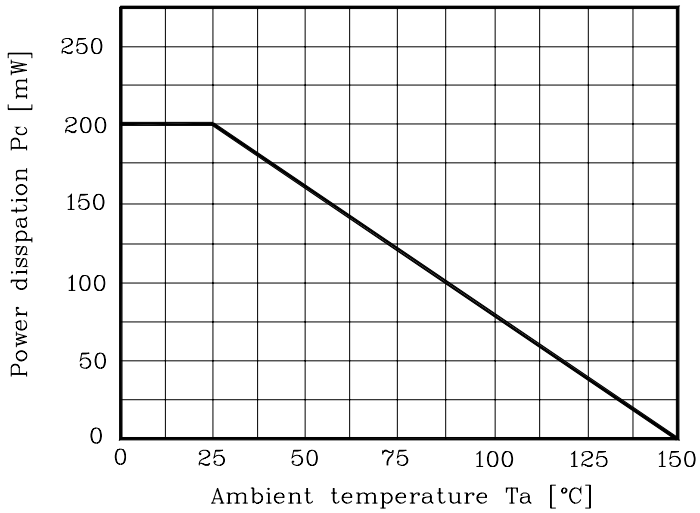

Fig. 2 $I_o - V_{I(ON)}$

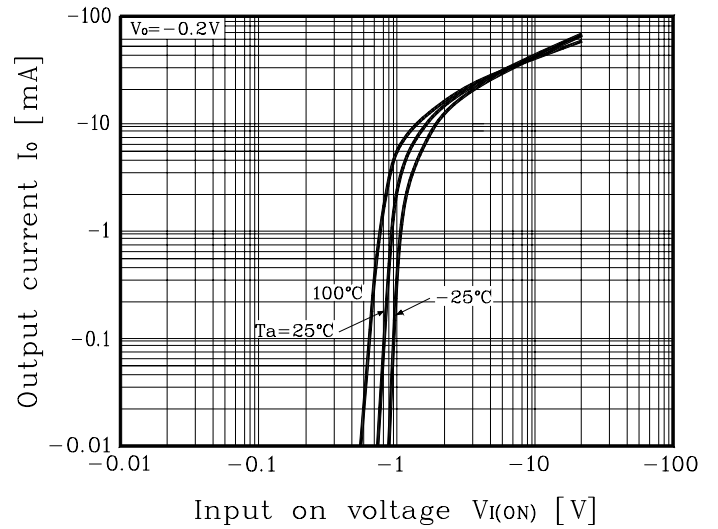

Fig. 3 $I_o - V_{I(OFF)}$

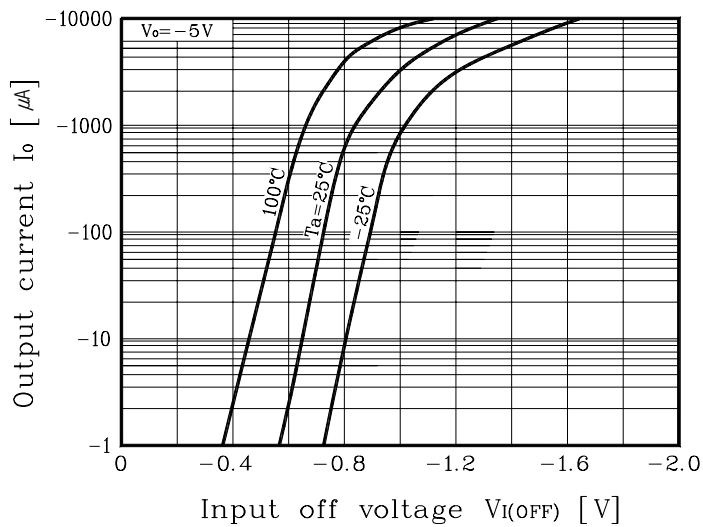
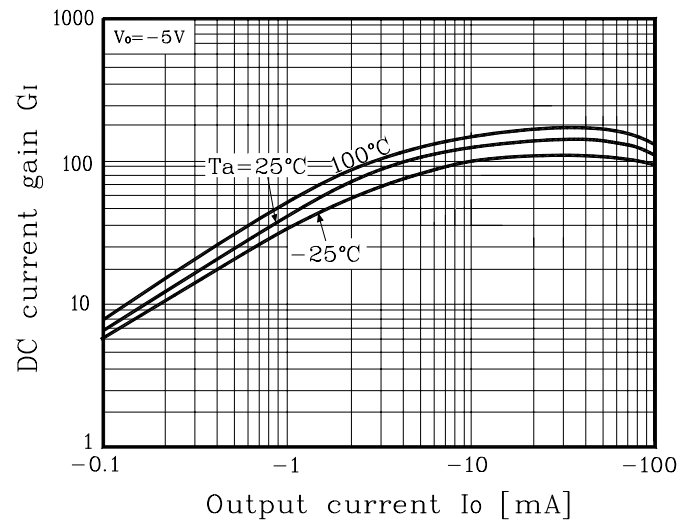
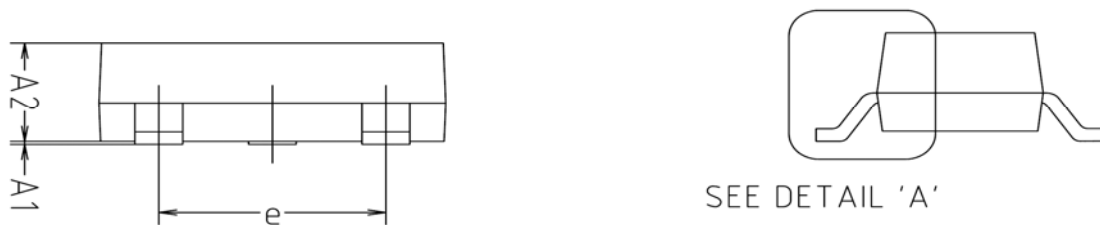
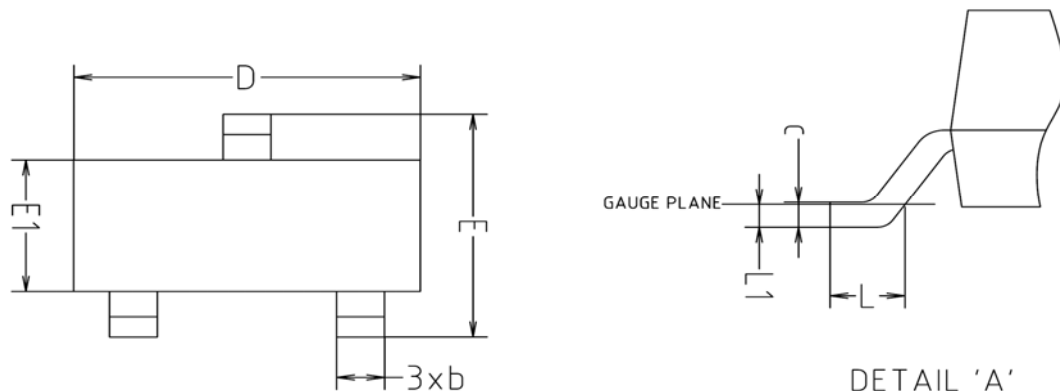

Fig. 4 $G_I - I_o$



Outline Dimension



| SYMBOL | MILLIMETERS | | | NOTE |
|--------|-------------|---------|---------|------|
| | MINIMUM | NOMINAL | MAXIMUM | |
| A1 | 0.00 | - | 0.10 | |
| A2 | 0.82 | - | 1.02 | |
| b | 0.39 | 0.42 | 0.45 | |
| c | 0.09 | 0.12 | 0.15 | |
| D | 2.80 | 2.90 | 3.00 | |
| E | 2.20 | 2.40 | 2.60 | |
| E1 | 1.20 | 1.30 | 1.40 | |
| e | 1.90BSC | | | |
| L | 0.20 | - | - | |
| L1 | 0.12BSC | | | |

※Recommend PCB solder land [Unit: mm]

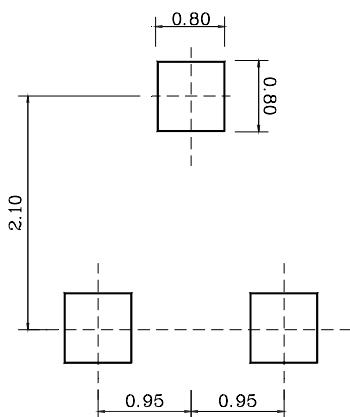

The AUK Corp. products are intended for the use as components in general electronic equipment (Office and communication equipment, measuring equipment, home appliance, etc.).

Please make sure that you consult with us before you use these AUK Corp. products in equipments which require high quality and / or reliability, and in equipments which could have major impact to the welfare of human life(atomic energy control, airplane, spaceship, transportation, combustion control, all types of safety device, etc.). AUK Corp. cannot accept liability to any damage which may occur in case these AUK Corp. products were used in the mentioned equipments without prior consultation with AUK Corp..

Specifications mentioned in this publication are subject to change without notice.